



Metcalfe High Volume Electric Chipper

EC20

Installation & Operating Instructions



Index

| | |
|-----------------------------|-----|
| Your Chipper | 3 |
| Technical Data | 4-5 |
| Optional Accessories | 5 |
| Unpacking | 6 |
| Installation | 7 |
| Operation | 8 |
| Cleaning Instructions | |
| Recommended Cleaning | 9 |
| Maintenance | 9 |
| Troubleshooting | 10 |
| Spare Parts & Service | 11 |
| Warranty | 12 |

Your Chipper



Metcalfe EC20 (High Volume Electric Chipper)

Features

- Production capacity of over 25kg of chips per minute, 192 rpm
- Total capacity of 20kgs, including hopper
- Interchangeable knife assembly offers a choice of four chip sizes: 10mm, 12mm, 14mm & 16mm
- The unit is not supplied with a knife assembly, please specify your preferred chip size(s) when ordering
- For use with wet, peeled potatoes
- Vee belt drive pulley for reliability and strength
- Manufactured from high grade 304 food safe stainless steel extending product life
- Heavy duty machined components for longer product life
- Thicker gauge material for a solid, more robust product
- Hopper, knife assembly and rotary feed are all removable for easy cleaning without the need for complicated removal tools
- All removable parts are dishwasher safe
- Stainless steel hopper with built-in ingredient baffles allows free movement of potatoes
- Zero volt reset preventing unplanned start-ups
- Safety interlocked hopper and knife block preventing unsafe use
- Emergency stop button, IP65 rated, preventing ingress of water
- Hand screw locking mechanism ensuring a full stop occurs before access to rotating parts
- Motor thermal protection preventing overheating and damage
- Counter-top mounting or optional floor stand available
- Non-slip feet preventing unwanted chipper movement
- CE & UKCA approved

Technical Specifications

| Model | Product Code | Capacity (kgs) | Output (kgs per min) | Phase (Ø) | Motor (V/Hz) | Power (kW/hp) |
|-------|--------------|----------------|----------------------|-----------|--------------|---------------|
| EC20 | 5EC22 | 20 | 25 | 1 | 230 / 50 | 0.18 / 0.25 |

Dimensions | Shipping Information

| Model | Overall Dimensions D x W x H (mm) | Net Weight (kg) | Packed Dimensions D x W x H (mm) | Packed Weight (kg) | Volume (m3) |
|---------------|-----------------------------------|-----------------|----------------------------------|--------------------|-------------|
| EC20 | 665 x 385 x 700 | 53 | 700 x 430 x 730 | 58 | 0.22 |
| Floor Stand | 505 x 460 x 510 | 10.5 | 520 x 475 x 525 | 11 | 0.13 |
| Floor Trolley | 505 x 460 x 590 | 11 | 520 x 475 x 605 | 11.5 | 0.15 |

Dimensions

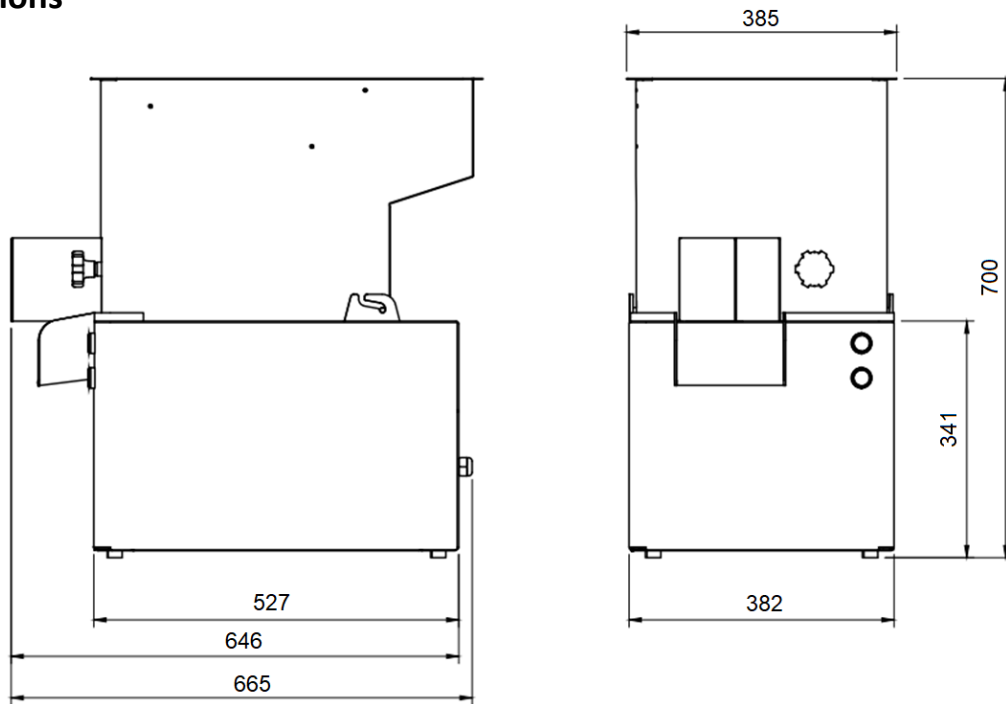

Optional Accessories

| Part No | Item |
|---------|---------------------------|
| 9ECM01 | 10mm Knife Block Assembly |
| 9ECM02 | 12mm Knife Block Assembly |
| 9ECM03 | 14mm Knife Block Assembly |
| 9ECM04 | 16mm Knife Block Assembly |
| 5EC24 | Floor Stand |
| 5EC25 | Floor Trolley |

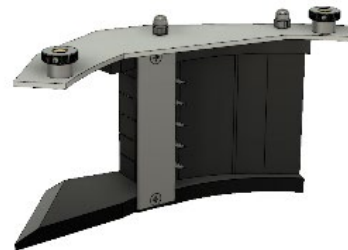

Stand & Trolley Dimensions

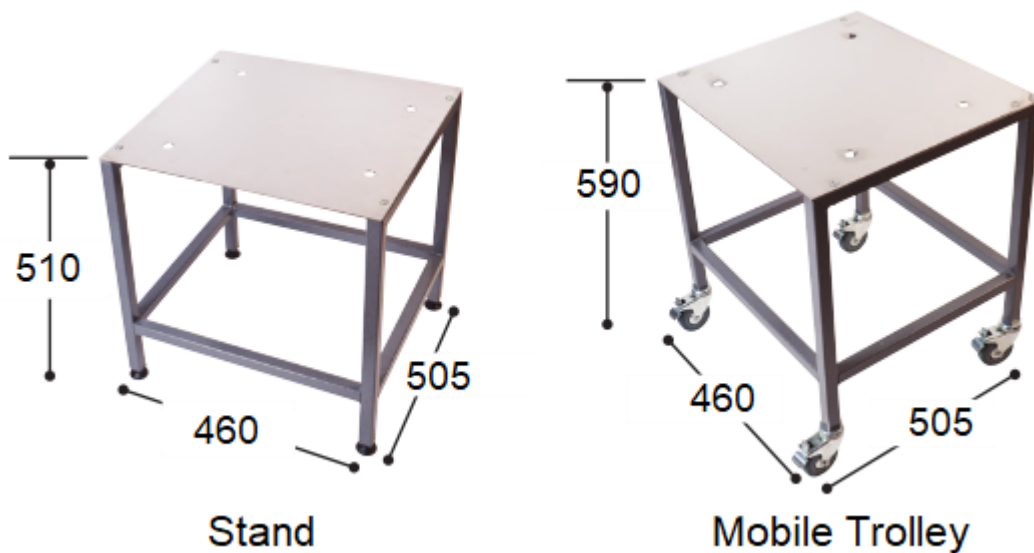

Unpacking

Unpack the chipper immediately after receipt. Please inspect the chipper to ensure no damage and all parts are present including the knife block assembly (supplied separately). If the machine is found to be damaged, keep all the packaging material and contact us immediately or contact your source of the equipment.

You should receive:-

1 x EC20 Chipper Body and Rotor

1 x EC20 Chipper Hopper and Locking Knob Assembly.

1 x Knife Block Assembly (ordered separately)

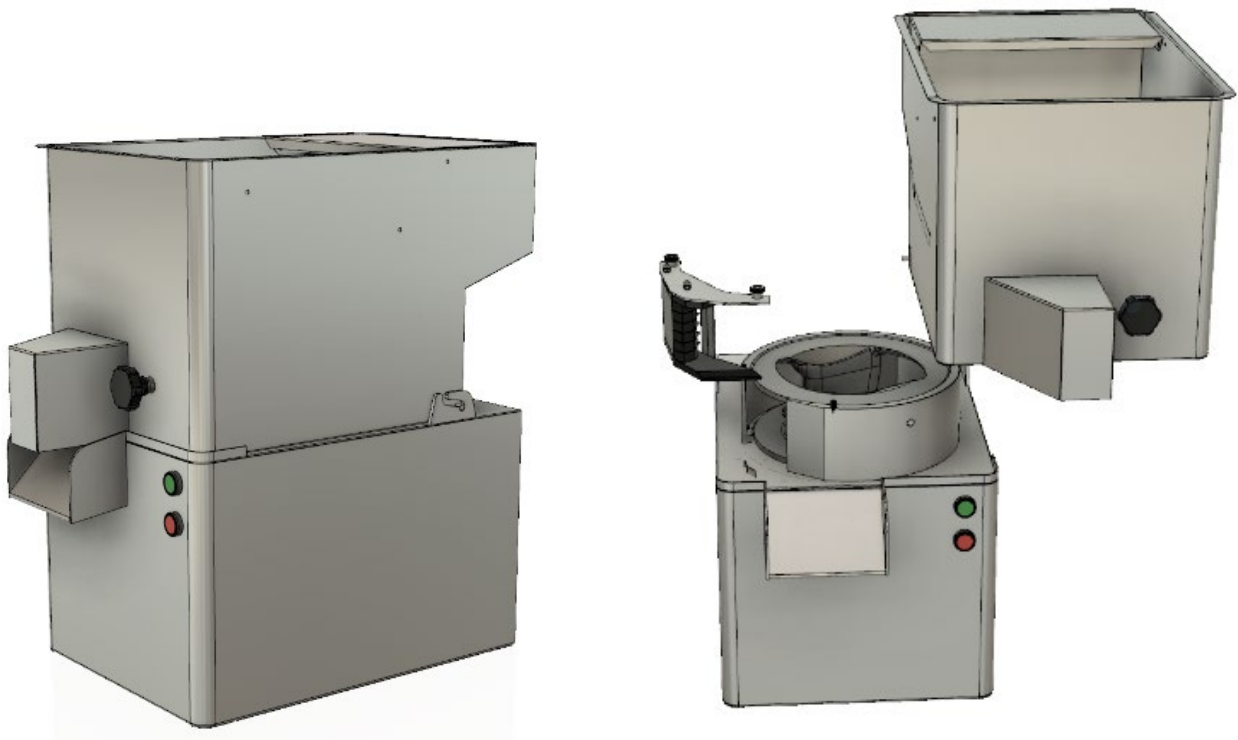

If any of the above items were not received with your chipper, please refer to page 11 for contact details and inform us immediately for replacements.

Installation

1. Before using the chipper please read this manual thoroughly. DO NOT proceed with any installation or operation if you have any questions or do not understand anything within this manual. Please see contact details on page 11 for assistance.
2. Carefully unstrap the chipper from the pallet.
3. Select a location for the chipper keeping these key points in mind:
 - Floor or counter must be level
 - Work surface or bench, trolley or stand, must be able to support a load of 75kg
 - Easy access for maintenance and servicing
 - Clearance for operating / opening the hopper
 - Sufficient space above the hopper to load the potatoes
4. If you purchased the Floor Stand or Floor Trolley, position the chipper on this prior to use, ensuring that the air vent opening on the stand is under the rear of the machine.
5. Please read the electrical information found on the data plate located at the rear of the machine. The incoming power should match the rating on the data plate.
6. The Electric Chipper 20 (EC20) comes with a fused 13 amp moulded plug. The supplying electrical supply should be connected via a 30A isolator providing at least 3mm separation in all poles.

| Model | Voltage / Hz | Phase (Ø) | Load Current | Fuse Rating per phase | kW / hp |
|-------|--------------|-----------|--------------|-----------------------|-------------|
| EC20 | 230 / 50 | 1 | 5.0 Amps | 13 Amps | 0.18 / 0.25 |

The supply to the machine must also be protected by a 30mA RCD.

Noise Test Report

The average A-weighted sound pressure level is 63dB.

Operation

Press the start button and with the machine running, feed **wet, peeled** potatoes into the hopper. It will hold approximately 20kg of potatoes, which self-feed into the mechanism of the machine and discharge as cut chips from the chute.

NOTE: do not leave the chipper unattended whilst in use.

Some care is necessary when loading, as the rotor will not accept abnormally large potatoes, so these must be cut into two. The hopper is specially designed not to pass potatoes which are over size, and which could otherwise clog the mechanism. The potatoes must be fed into the machine steadily and not emptied into the hopper all at once as this could lead to the rotor jamming.

It is also essential that only potatoes be fed into this machine.

NOTE: take great care to ensure that there are no stones mixed in with the potatoes.

A stone or any other foreign object will damage the cutting knives and could cause the machine to jam. In this event the machine has an inbuilt protection device, which will switch it off before the electric motor burns out. This overload protection feature will automatically reset itself when it cools down, but it is necessary to wait a few minutes for this to happen. After clearing the jam resume operation by pressing the start button. Should a stone damage the knife blades they must be replaced as further use could break the blades.

This chipper is designed for batch process work; switch the machine off once all the potatoes have been cut. The motor is fitted with a thermal trip that will stop the machine if the motor overheats. This protection feature will automatically reset itself when it cools down, but it is necessary to wait a few minutes for this to happen.

The machine will switch itself off in the event of failure of the electricity supply whilst operating. When the supply is restored, the machine must again be switched on. It is fitted with no-volt release.

Changing Chip Size

To change to a different size of chip, change the knife block assembly. Spare knife block assemblies are available from Metcalfe. Open the hopper, lift out the knife block and replace with the alternative selected. Knife blocks are available in the following sizes from the standard range: 10mm, 12mm, 14mm, and 16mm.

Cleaning Instructions

ALWAYS disconnect or unplug the electrical power from the chipper before cleaning.

NEVER use a scrubber pad, steel wool, or abrasive material to clean the chipper.

NEVER use bleach or bleach-based cleaner.

ALWAYS remove the knife assembly after each batch otherwise the assembly can become stuck on the locators and difficult to remove.

Recommended Cleaning

| Part | Required Action | Frequency |
|----------------|--|----------------------|
| Knife Assembly | Hand wash using soap and water, rinse, dry and sanitise. Inspect all blades after each use. | Clean after each use |
| Rotor | Hand wash using soap and water, rinse, dry and sanitise. | Clean after each use |
| Hopper | Hand wash using soap and water, rinse, dry and sanitise. | Clean after each use |

Maintenance

Regular maintenance by a qualified engineer is necessary to keep the chipper running smoothly and problem free. Please ask our service department for details.

| Part | Required Action | Frequency |
|--------------|--|-------------|
| Drive System | Inspect the drive belt for damage ensuring no damage or fraying is present. | Once a year |
| Electrics | Unplug the chipper and remove the base plate to access the electrics. Ensure all clips and connectors are clean and undamaged. | Once a year |
| Electrics | Pat Test | Once a year |

Troubleshooting

| Problem | Possible Causes | Required Action |
|--------------------------------|--|---|
| Chipper will not start | Hopper not in place correctly. | Unscrew the hopper handle and refit the hopper. |
| | Knife block assembly not fitted. | Fit knife block assembly making sure the base is clean. |
| | Power not connected correctly. | Check all power connections. Plug into a live socket. DO NOT use an extension cord. Test socket with another item. |
| | Building circuit breaker is off. | Check breaker box. |
| Chipper stops during operation | Damaged or broken transmission belt. | Replace belt. |
| | Chipper is not installed on a level surface. | Adjust surface or relocate chipper. Make sure the rubber feet are fitted. |
| Chipper is noisy | Rotor is not seated correctly | Remove rotor, clean and refit to chipper. |
| | Damaged or worn belt. | Replace belt. |
| | Noisy belt. | Check belt tension and adjust accordingly. |

Spare Parts and Service

| Part No | Item |
|---------|--|
| 9ECM01 | 10mm Knife Block Assembly |
| 9ECM02 | 12mm Knife Block Assembly |
| 9ECM03 | 14mm Knife Block Assembly |
| 9ECM04 | 16mm Knife Block Assembly |
| 9ECM05 | 10mm Set of Replacement Blades |
| 9ECM06 | 12mm Set of Replacement Blades |
| 9ECM07 | 14mm/16mm Set of Replacement Blades |
| 9ECM08 | Replacement Chipping Blades (pack of 5) |
| 9ECM09 | Replacement Chipping Blades (pack of 10) |
| EC816 | Replacement Slicing Blade |

For more information on Metcalfe spare parts, accessories and service support, including breakdown drawings and parts lists please contact us on the details below.

Please always quote the Serial Number of the machine. This can be found on the serial number plate which is located on the rear of the machine.

Metcalfe Sales & Spares Department sales@metcalfecatering.com

Metcalfe Service Department service@metcalfecatering.com

Metcalfe Website www.metcalfecatering.com

Metcalfe Telephone Number 01766 830 456



Additional copies of this instruction manual can be obtained by either visiting our website or contacting the sales department.

Metcalfe Warranty

All Metcalfe products are guaranteed against defects in material and workmanship for a period of one year from date of Invoice, except where specially noted.

The Company's obligation under this warranty is limited to repairing or replacing, without charge, any part or parts found to be defective under normal use, in accordance with the specified operations manual and capacity ratings.

On all return to factory warranty items, it is the responsibility of the purchaser to return the entire unit to the factory, in a clean condition, properly packed and labelled.

All repairs, alterations or replacement of materials or parts not authorised by Metcalfe will automatically void all warranties in their entirety.

The Metcalfe EC20 Chipper is covered by a 2-year warranty (1st year parts and labour, 2nd year parts only) and full after sales service.

There is a limited 6-month warranty on the following:

- Slicing Blade(s)
- Chipping Blades
- Parts purchased or supplied for the repair of Metcalfe equipment

This warranty does not cover the following:

- Failure due to neglect, abuse, careless handling or misuse of machine
- Failure caused due to improper maintenance
- General wear and tear

Metcalfe and its suppliers reserve the right to make changes in design and specification to any product without prior notification.

Some other products in the Metcalfe portfolio:

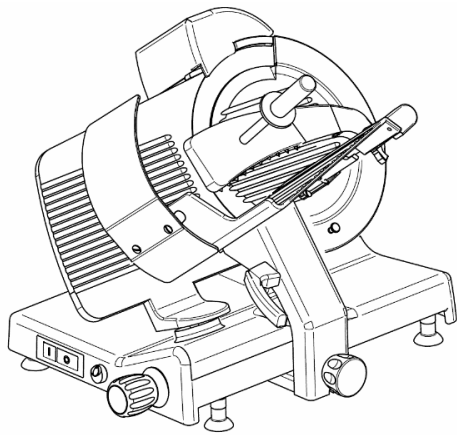

NS Slicers

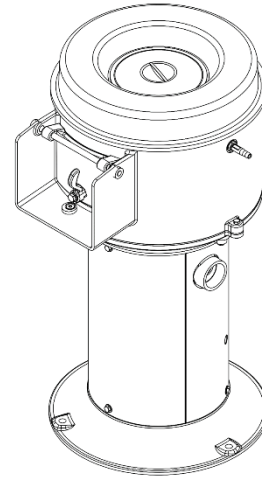

Potato Peelers



Ceado

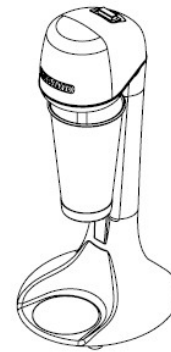

Roband



Food Preparation Machines

Made in Sweden 



hallde.com

8/2023

Metcalfe Catering Equipment Ltd

Haygarth Park
Blaenau Ffestiniog
Gwynedd, LL41 3PF



 01766 830 456  sales@metcalfecatering.com  www.metcalfecatering.com