



Metcalfe MP20

20 Litre Heavy Duty Bench Mounted Mixer

Installation & Operating Instructions



Index

Your Mixer	2
Technical Data	3
Installation	
- Unpacking	4
- Location	4
- Electrical Connection	5
Operation	
- Fitting the Bowl	6
- Bowl Lift and Guard	6
- Tool Selection	6
- Fitting Attachments	7
- Operation	7
- Speed Selection	7
- Recommended Mixing Capacities	8
- Attachment Hub	9
Cleaning	10
Maintenance	10
Troubleshooting	11-12
Spare Parts & Service Contact Details	13
Warranty	14

Your Mixer

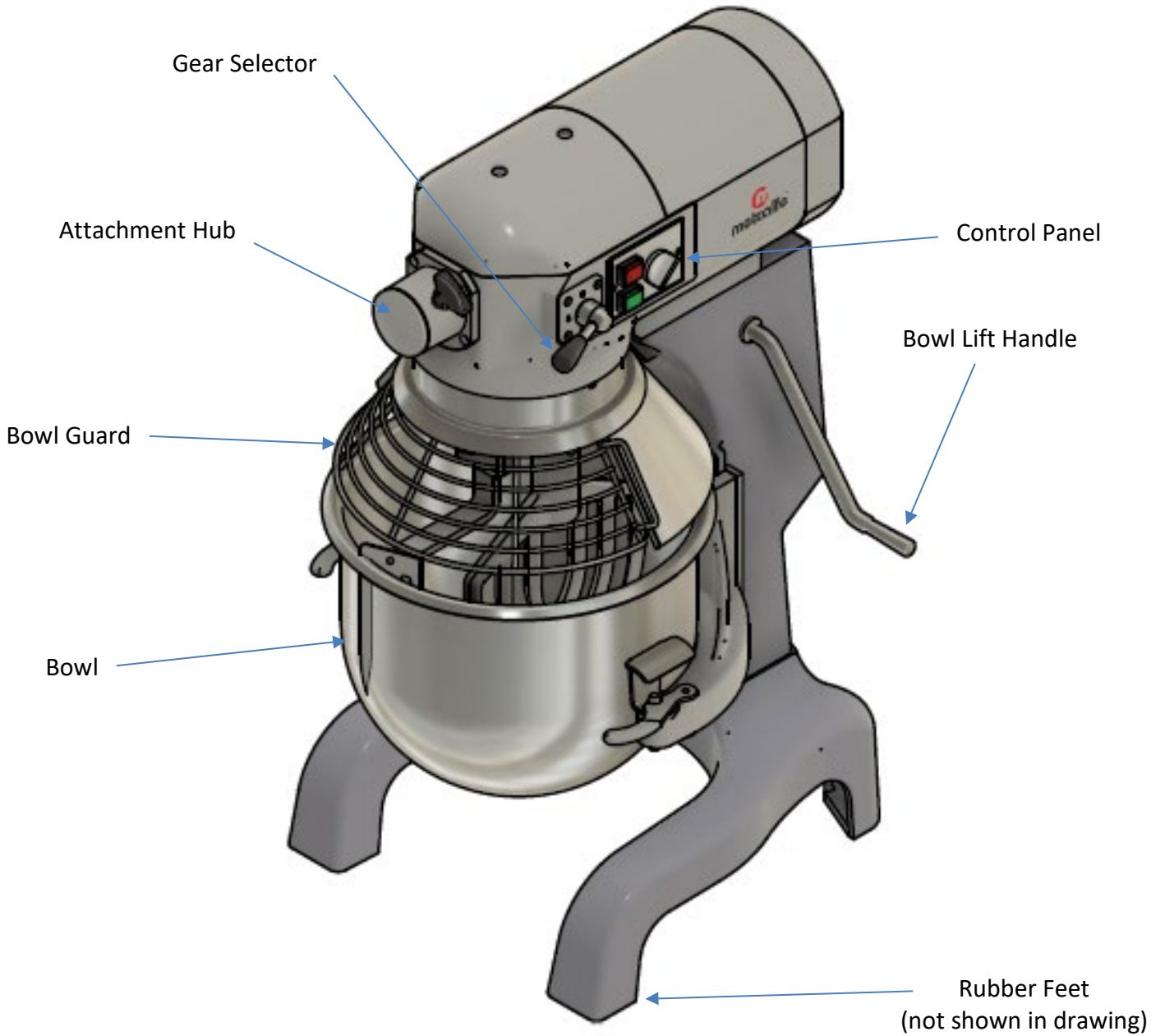

Metcalfe MP20 (20 Litre Heavy Duty Mixer)

The Metcalfe MP20 has a total bowl capacity of 20 Litres. The three mixing tools provided ensure that all mixing requirements are met.

Features

- Gear driven
- Three speeds (140, 260 and 473) rpm
- Heavy duty heat-treated steel gears and shaft
- CE approved
- Safety interlocked bowl guard and bowl lift
- Stainless steel guard
- Emergency stop button
- Dual bowl clamps to lock bowl down
- Heavy duty gearbox
- Protective non-slip covers for feet to protect counters and provide stability
- Heavy duty, cast iron frame
- No volt release
- Resettable thermal overload
- Industry standard #12 attachment hub
- Optional meat mincer attachment available
- Optional veg prep attachment available
- Optional 10-litre conversion parts available
- Optional stand or mobile trolley

Specifications

Model	Capacity (Litres)	Phase (Ø)	Motor (Volt)	Frequency (Hz)	Power (kW / Hp)	Dimensions D x W x H (mm)	Net Weight (Kg)
MP20	20	1	230	50	0.375 / 0.5	530 x 464 x 810	98

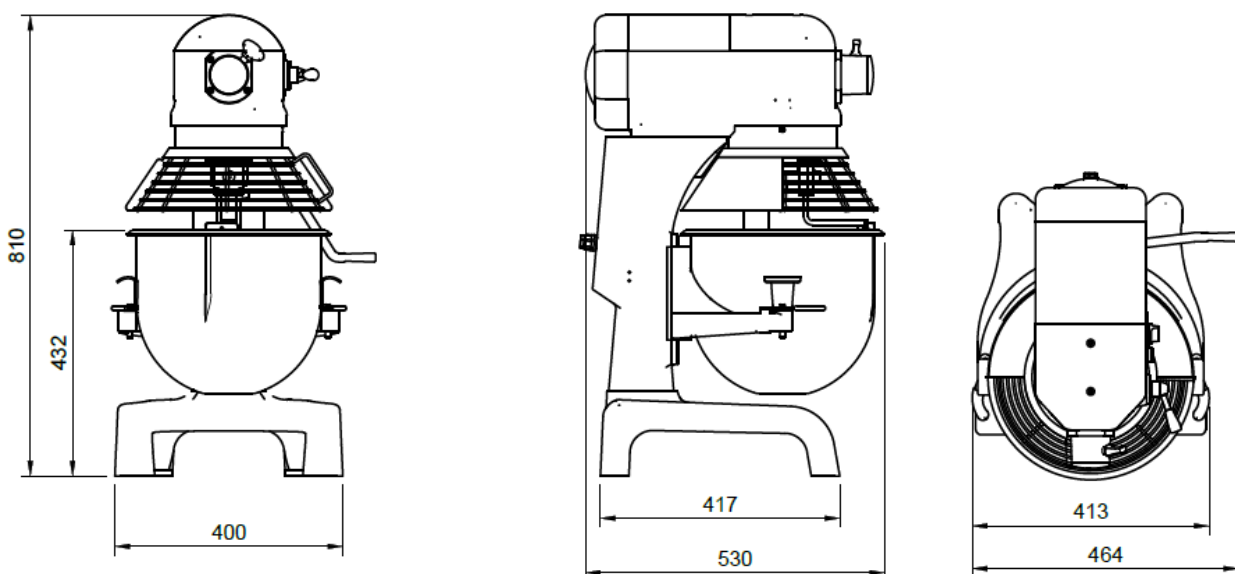

Installation

Unpacking

Unpack the mixer immediately after receipt. Please inspect the mixer to ensure no damage and all parts i.e. Bowl, Beater, Whisk & Dough Hook have been provided. If the machine is found to be damaged, keep all the packaging material and contact us immediately or contact your source of the equipment. Never attempt to operate the machine with damaged parts. Report any deficiencies to the dealer that supplied the machine.

You should receive with your mixer:

- 1 x Stainless Steel Bowl
- 1 x Beater
- 1 x Whisk
- 1 x Dough Hook

If any of the above items were not received with your mixer, please refer to page 13 for contact details and inform us immediately for replacements.

Before using the mixer please read this manual thoroughly. Do not proceed with any installation nor operation if you have any questions or do not understand anything within this manual. Please see contact details on page 13 for assistance.

Carefully unbolt the mixer from the pallet using a wrench socket.

PLEASE NOTE: If the unit was supplied with Stand or Trolley, **DO NOT** dispose of the bolts as these will be required to secure the unit to either the Stand or Trolley.

Location

- Select a location for the machine with a minimum of 0.6m space around the machine for operating, cleaning and servicing.
- Position the machine in its proper working position. The machine must be installed on a flat, solid and dry floor. It is also suitable for bench mounting.
- The surface must be able to support a load of 122kgs
- It is recommended that the machine is level from front to back and from side to side. This will ensure the greatest stability.
- The rear ventilation outlet of the mixer must not be blocked
- The mixer should be bolted down into position using all four holes located in the legs.

Electrical Connection

- Before connecting the mixer to an electrical supply, please read the specifications on the rating plate to ensure that they comply with those of the electrical supply.
- Electrical connection should be made by a qualified service technician who will observe all applicable safety codes. The machine works off 220/240V 50Hz 1 phase supply and comes fitted with a 3-pin 13amp fused plug.
- An electrical supply should be available within the reach of the included power cord. **DO NOT** use extension cords to connect the machine's power cord to the electrical supply. The low AMP supply could damage the mixer or cause a fire.
- The technician should install an over-current protection device (e.g. fuse or NFB) or Residual Current Device (GFCI) to prevent a current fault risk.
- Ensure that an isolating switch is fitted within 2m of the machine.
- All wiring connections must be checked and tight.

Hard Wiring

- The mixer can be hardwired into a switched socket which isolates all poles and has a minimum contact clearance of 3mm. It should be located close to the mixer for use in an emergency and to facilitate servicing.
- The machine must be incorporated into a potential equalization system.
- The leakage current for this appliance is no greater than 1 mA/KW.
- If the electrical supply cable to the machine becomes damaged, it must be replaced by the same specification or higher and suitable for the mixer's motor load.
- **The ground wire is fixed to the machine and this connection must be kept intact.**
- CAUTION: The mixer MUST be grounded.

3 Phase Connection

If you have a 3-phase mixer, when it is in position and connected, **please make sure that the shaft goes clockwise.** (Same direction as the arrow sticker that located on the front of the mixer). If the shaft goes counter-clockwise, please exchange the position of 2 phase wires: replace L3 with L2.

The mixer should be hardwired into a switched socket (see above).

Ambient Conditions

- The minimum requirement for all electrical equipment's correct operation is an air temperature of between +5°C and +40°C.
- Electrical equipment is capable of operating correctly when the relative humidity does not exceed 95% at a maximum temperature of +40°C.
- Electrical equipment is capable of operating correctly at altitude up to 1000m.
- Electrical equipment is designed to withstand and be protected against the effects of transportation, and storage temperature within a range of -25°C to +55°C and for short periods not exceeding 24h at up to +70°C.

Once the electrical connection has been made, the machine is ready for use.

Operation

Fitting the Bowl

NOTE: Install the bowl **BEFORE** attaching the agitator.

1. Lower the bowl lift handle anti-clockwise and down to its resting position.
2. Lift the bowl by the handles and slowly position the locking pin located at the rear of the bowl into the hole in the middle rear of the cradle. (Figure A)
3. Lower the bowl onto the pins located on either side of the bowl cradle.
4. Once the bowl is in position, secure it by pulling each bowl clamp forward until the bowl is locked tight. (Figure B)



(Figure A)



(Figure B)

Bowl Lift & Guard

Move the bowl lift handle anti-clockwise to lower the bowl. It is necessary to lower the bowl to change the tools, and to provide better access for filling and emptying the bowl. To raise the bowl, move the bowl lift handle clockwise until it hits the upper stops.

The bowl cradle and guard are electrically interlocked so that the mixer will only operate when the bowl is in the raised position and the guard is locked in place. This ensures total user safety at all times.

Once the guard has been opened and the bowl lowered the mixer can only be restarted by pressing the start button.

During operation additional ingredients can be added via the ingredients chute located on the right-hand side of the bowl guard.

Tool Selection

The beater, whisk and dough hook are meant for the work implied by their names. Do not use the beater for dough making or the whisk for anything other than whisking, aerating or mixing light mixtures. These are the typical uses for each of the tools supplied:



Whisk

Light mixes such as whipped cream, mayonnaise, egg whites, pancakes and soufflés



Beater

Firm mixes such as light pastry, cakes, biscuits, icing, fillings and mashed vegetables



Dough Hook

Heavy mixes such as dough and pastry

Fitting Attachments

NOTE: Install the bowl **BEFORE** attaching the mixing tool.

NOTE: It is easier to install the attachment prior to adding ingredients into the bowl.

Open the bowl guard and lower the bowl.

Slide the attachment slowly upwards onto the planetary shaft, fitting the shaft pin through the slot in the attachment. (Figure A)

Rotate the attachment clockwise to secure it onto the planetary shaft.

NOTE: Attachments should always rotate in a clockwise direction around the bowl. If an attachment is moving counter-clockwise please contact a licensed electrician immediately to remedy incorrect wiring.

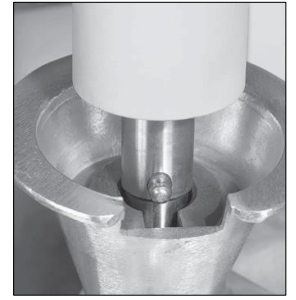

(Figure A)

Operation

- Place the gear selector handle to 1st gear, then turn on the machine. You will have to lift the bowl and close the safety guard before you will be able to start the machine.
- The machine must always be stopped before changing speeds. Failure to do so may damage the gears or other parts and will void the warranty.
- Never place your hand or any kitchen utensil in the bowl whilst the mixer is in operation.
- Never operate this machine with safety covers removed or with safety switches inoperative.
- When mixing is complete, turn off the machine and lower the bowl by lift handle/lever then take off the attachment.
- Then take out the bowl together with attachment.
- Finally take out the mixed ingredients.
- Please follow the capacity chart on the following page. Overloading or not following the chart will damage the mixer and void the warranty.

Speed Selection

To change speeds, first turn off the mixer, then move the gear selector handle to the desired speed before restarting the mixer by pressing the start button.

Number 1 is the slowest speed and number 3 is the highest speed.

















Slow Speed: for heavy mixtures such as dough, biscuits, etc.

High Speed: for fast, light work, such as whipping cream, beating eggs, and mixing thin substances.

The speed selected depends largely on the quantity and consistency of the product. It is recommended that mixing is always started at the lowest speed and progressively increased to the desired setting. In an emergency situation always use the red emergency stop button to stop the mixer. The below table show the recommended speeds for the range of tools.

	1 st Gear	2 nd Gear	3 rd Gear
Whisk	→		
Beater	→		
Dough Hook	→		

Recommended Mixing Capacities

Product	Agitator	Speed	MP20
Egg Whites		All	0.9 ltr
Mayonnaise (quantity of Oil)		All	8 ltr
Meringue		All	1.7 ltr
Whipped Cream		All	3.5 ltr
Mashed Potatoes		1 st & 2 nd	6.5 kg
Waffle / Pancake Batter		1 st & 2 nd	7 ltr
Cake Batter		1 st & 2 nd	9 kg
Sponge Cake		1 st & 2 nd	6 kg
Pie Dough		1 st & 2 nd	8 kg
Bread or Roll Dough (Light/Med, 60% AR)		1 st only	4 kg
Bread or Roll Dough (Heavy, 55% AR)		1 st only	3.5 kg
Thin Pizza Dough, Pasta, Basic Egg Noodle (40% AR) 5 min max mix time		1 st only	3 kg
Medium Pizza Dough (50% AR)		1 st only	3 kg
Thick Pizza Dough (60% AR)		1 st only	4 kg
Raised Donut Dough (65% AR)		1 st only	3 kg
Whole Wheat Dough (70% AR)		1 st only	4 kg

- Never use 2nd speed when mixing dough
- If high gluten flour is used, reduce dough batch size by 10%
- Capacities listed are based on flour at room temperature and water at 20°C. If using chilled flour, water below 20°C, or ice, reduce batch size by 10%
- The Absorption Ratio (AR) of a product is calculated by dividing the water weight by the flour weight, e.g. to calculate the AR of a mixture containing 50g of water and 100g of flour: $5 \div 10 = 0.50 = 50\%$ AR.

Attachment Hub

Never put your hand into the feed chute when using any mixer attachment.

The mixer must be OFF before installing attachments! Do NOT use attachments while mixing!

1. Loosen and remove the attachment hub thumbscrew
2. Remove the cover from the attachment hub
3. Lubricate the attachment shaft with a food quality grease or mineral oil
4. Insert the attachment shaft into the hub making sure to line up the alignment pin with the hub hole.
5. Tighten the thumbscrew back into the hub and securely tighten it.
6. Select the appropriate speed setting by lifting or lowering the speed control lever.

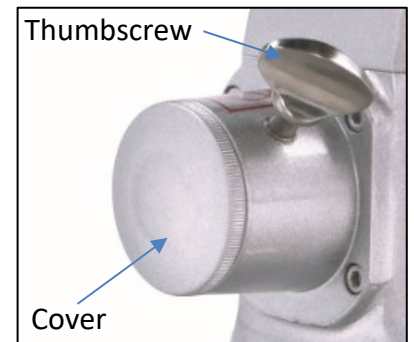

NOTE: Make sure the bowl is up and the bowl guard is closed otherwise the mixer will not start.

7. Press the start button located on the middle of the control panel.
8. Always stop the mixer before changing speeds. Failure to do so may damage the gears or other parts and will void the warranty.
9. To change the speed while using the mixer attachments, first press the stop button, then change the speed using the gear control lever. Then press the start button to restart the machine.

The below table shows the recommended speeds while using the hub attachments:

Recommended Speed			
	1 st Gear	2 nd Gear	3 rd Gear
Slicing	→		
Grating	→		
Mincing	→		

Cleaning Instructions

ALWAYS disconnect from the power source when cleaning or servicing this machine.

ALWAYS remove the attachment/s after each batch. If not, the attachment/s can become stuck on the shaft and difficult to remove.

NEVER attempt to clean this machine while it is in motion, serious injury could result.

NEVER use a scrubber pad, steel wool, or abrasive material to clean the mixer.

NEVER use bleach or bleach based cleaner.

Recommended Cleaning

Part	Required Action	Frequency
Attachments	Hand wash using soap and water, rinse, dry and sanitise.	Clean after each use
Guard	Hand wash using soap and water, rinse, dry and sanitise.	When required
Bowl	Using a sponge or cloth, soap and water, apply pressure to ensure the bowl is clean, rinse, dry and sanitise. The bowl can also be placed in a dishwasher	Clean after each use
Solid Bowl Guard	Hand wash using soap and water, rinse, dry and sanitise.	Clean after each use
Bowl Cradle	Hand wash using soap and water, rinse, dry and sanitise.	Daily
Planetary Shaft	Wipe with a clean damp cloth, dry & sanitise.	Clean after each use
Exterior	Hand wash using soap and water, rinse, dry and sanitise.	Daily
Hub Interior	Wipe with clean damp cloth, dry & sanitise.	Daily

Maintenance

Regular maintenance is necessary on all mixers if they are to run smoothly and problem free.

Part	Required Action	Frequency
Planetary Ring	Reapply grease. Inject grease (2 pumps only) into fitting on the side of planetary housing. DO NOT overfill	Once a year.
Bowl Slide Rods	Apply food quality grease on the bowl slide rods. Raise and lower the bowl to distribute the grease onto the rods.	If the bowl becomes difficult to raise or lower.

Troubleshooting





Problem	Possible Causes	Action Required
Mixer will not turn	Bowl guard not in closed position	Rotate guard to the right until fully closed.
	Bowl not raised	Raise bowl to highest position.
	Power not connected correctly	Check all power connections. Plug into a live socket (<i>do not use extension cord!</i>). Test socket with another item.
	Building circuit breaker is off	Check breaker box
	Internal overload tripped	Wait two minutes. Press stop button then press start button. (<i>If overload continues to trip, reduce batch size and/or adjust recipe!</i>)
	Gear not engaged	Switch gear fully into position. (<i>Mixer will not operate if the speed control lever is positioned in-between speeds</i>)
Mixing stops during mixing	Internal overload tripped	Wait two minutes. Press stop button then press start button. (<i>If overload continues to trip, reduce batch size and/or adjust recipe!</i>)
Mixer is noisy	Mixer is not installed on level surface	Adjust surface or relocate mixer. Make sure the rubber feet are installed
	Bowl not seated correctly or clamps not in place	Ensure bowl is seated into bowl cradle correctly and bowl clamps are locked into place
	Attachment not fitted properly	Remove and re attach attachment into position correctly
	Overloading bowl	Reduce batch size (see capacity chart)
	Planetary ring gear needs more grease	Technician to inspect for source of noise
Safety guard seized (will not move freely)	Clean & lubricate slide sheath	Technician must drop down planetary assembly to access mat & sheath
Attachments won't go onto the planetary shaft easily	Lack of lubrication and / Or cleaning of the planetary shaft	Wipe planetary shaft with a clean damp cloth and lubricate the shaft with mineral oil or food quality grease
Mixing time is too long	Three-phase mixer is wired incorrectly	Attachments should rotate clockwise around bowl. If not, electrician must rewire
	Batch size too small	Increase batch size or use half size conversion kit
Bowl lift sticking or not operational	Lack of lubrication on bowl slides	Lubricate bowl slides with food quality grease. If still sticking, technician must clean bowl lift mechanism
One or more gears not working	Damaged or broken gear(s)	Technician to replace gears. Always stop mixer before changing gears.
Mixer will not mix medium or heavy loads	Incorrect or low voltage	Contact electrician

Problem	Possible Causes	Action Required
Residue leaking from hub	Contaminated hub due to food build-up	Technician to remove hub and clean interior. To avoid problem, always wipe hub and dry after each use
Attachments touching bottom or sides of bowl	Defective or dented bowl	Remove dents or replace bowl
	Defective attachment	Replace attachment
Broken whisk wires	Batch size too large for mixer Items too firm Speed too high	Reduce batch size (see Capacity Chart) Adjust recipe Reduce speed
	Hand utensil dropped into bowl while mixing	Stop mixer before working on mixture
Broken beater	Ingredients too cold or too large (e.g. frozen butter/cream cheese cut in chunks)	Wait for ingredient to reach room temperature before mixing Reduce chunk size
Broken dough hook	Batch size too large for mixer	Reduce batch size (see Capacity Chart) Adjust recipe
	Ingredients too cold or too large	Wait for ingredients to reach room temperature before mixing Reduce chunk size
Discoloration of mixed product	Bowl has not been cleaned thoroughly	Clean bowl again (refer to page 10)

Spare Parts and Service

For more information on Metcalfe spare parts, accessories and service support, including breakdown drawings and parts lists please contact us on the details below.

Please always quote the Serial Number of the machine. This can be found on the serial number plate which is located on the rear of the machine.

			
metcalfe TM			
Tel: +44 (0)1766 830 456 Fax: +44 (0)1766 831 170			
Serial No:			
Model:		Phase:	
V	Hz	W	
M:	Yr:	Kg	

Metcalfe Sales & Spares Department

sales@metcalfecatering.com

Metcalfe Service Department

service@metcalfecatering.com

Metcalfe Website

www.metcalfecatering.com

Metcalfe Telephone Number

01766 830 456



Additional copies of this instruction manual can be obtained by either visiting our website or contacting the sales department.

Metcalfe Warranty

All Metcalfe products are guaranteed against defects in material and workmanship for a period of one year from date of Invoice, except where specially noted.

The Company's obligation under this warranty is limited to repairing or replacing, without charge, any part or parts found to be defective under normal use, in accordance with the specified operations manual and capacity ratings.

On all return to factory warranty items, it is the responsibility of the purchaser to return the entire unit to the factory, in a clean condition, properly packed and labelled.

All repairs, alterations or replacement of materials or parts not authorised by Metcalfe will automatically void all warranties in their entirety.

All Metcalfe slicers (except Simple Line) are covered by a 2-year warranty (1st year parts and labour, 2nd year parts only) and full after sales service.

All Metcalfe MP mixers are covered by a 3-year warranty (1st year parts and labour, 2nd & 3rd year parts only) and full after sales service.

There is a limited 6-month warranty on the following:

- Mixer attachments (beater, whisk and dough hook)
- Chipper blades
- Parts purchased or supplied for the repair of Metcalfe equipment

This warranty does not cover the following:

- Failure due to neglect, abuse, careless handling or misuse of machine
- Failure caused due to improper maintenance
- Blender clutches
- Knives and gears on can openers
- Sharpening of slicer blades
- General wear and tear

Metcalfe and its suppliers reserve the right to make changes in design and specification to any product without prior notification.

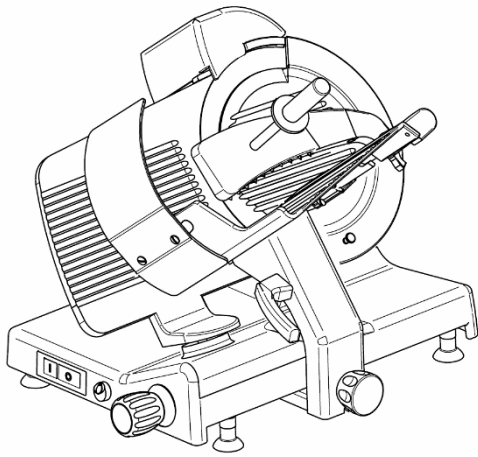

NS Slicer Range

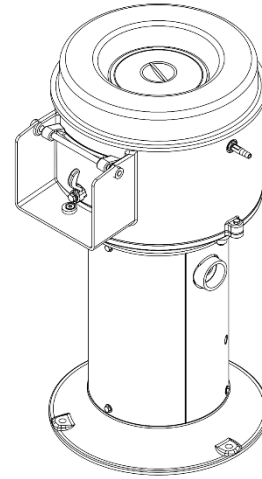

Peeler Range



Ceado

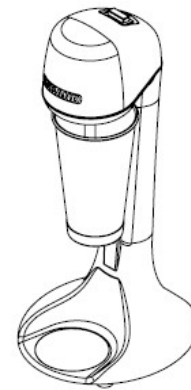

Roband



Food Preparation Machines

Made in Sweden 



halde.com

1/2024

Metcalfe Catering Equipment Ltd
Haygarth Park
Blaenau Ffestiniog
Gwynedd, LL41 3PF

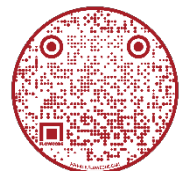

 01766 830 456

 sales@metcalfecatering.com

 www.metcalfecatering.com