

Instruction Manual

GRILL STATION – HIGH SPEED CONTACT GRILL



MECHANICALLY CONTROLLED DEVICES

GSA610 Version 4
GSA810, GSA815 Version 3



ELECTRONICALLY CONTROLLED DEVICES

GSA610SE Version 1
GSA810SE, GSA815SE Version 1

CONTENTS

Product Features	2
Specifications	2
Parts Included	2
Safety Instructions	2
Compliance	3
Cleaning & Maintenance	3
Non Stick Coated (T) Series	4
Installation	4
Australian models	4
Export Models (-g, -f & -m)	4
operation of grill stations	4
Additional Information	6
Seasoning	6
Cooking	6
Caution	7
Troubleshooting	7
Parts List	8
Circuit Diagrams	9
Heat Shield Installation	10
Warranty	11

PRODUCT FEATURES

- High Temperature Capacity
- Timer Alarm
- Advanced Control Safety Systems
- Embedded Elements for Rapid Heating
- Fast Recovery & Maximum Life
- High Quality, Rapid Heating Aluminium
- Non-Stick Coating (T Series)
- 8 Programmable times (E Series)

SPECIFICATIONS

Model	Power (230V)	Size (mm)			Kg
		W	D	H	
GSA610	2200W	435	490	228	17.3
GSA810	2300W	560	490	228	23
GSA815	2990W	560	490	228	23
GSA610SE	2200W	435	490	248	17.3
GSA810SE	2300W	560	490	248	23
GSA815SE	2990W	560	490	248	23

*Specifications subject to change

PARTS INCLUDED

- Grill Station (appropriate model)
- 'T' models include non-stick coating
- 'E' models include electronic timer
- Grease Box
- Nylon Spatula
- This Instruction Manual

Any damage to the appliance as a result of freight must be reported to the freight company and to the agent responsible for the despatch within 24 hours of receipt. No claims will be accepted after this period.

SAFETY INSTRUCTIONS

Read all instructions and safety warnings prior to use. Keep user manual for future reference.

Service and repairs should only be performed by qualified technicians who have read and understood this manual.

Personnel must be trained prior to operating this appliance.

This product is suitable for commercial use only.

This appliance should not be operated by persons (including children) with reduced physical, sensory or mental capabilities, or lack

of experience or knowledge, unless they have been given supervision or instruction concerning the safe use of the appliance by a person responsible for their safety.

Keep out of reach from children.

Avoid contact with the exterior of this appliance as surfaces can get hot.

Do not position appliances where hot surfaces may be accidentally touched.

The appliance should be disconnected from all power and allowed to cool before cleaning or servicing.

Regularly inspect the electrical supply cord and plug and discontinue use immediately if damage is found. Return to manufacturer or authorised repairer for repair prior to use.

This appliance contains non user-serviceable parts. Roband Australia, one of our agents, or a similarly qualified person(s) should carry out repairs.

Steel cutting technology used in the manufacturing of this unit can create sharp edges. Care must be taken when handling the unit during servicing, cleaning and maintenance.

Keep cord away from heated surfaces.

Do not remove any cover panels from the appliance.

Hot surfaces must be well ventilated with a minimum 100mm clearance around the Grill Station.

No part of this unit is dish-washer safe.

Do not pour cold water or ice on the unit if the plates are at medium to high temperature. This may cause the plates to buckle from the sudden change in temperature.

Roband® will accept **no liability** if:

- Non-authorised personnel have tampered with the appliance
- The instructions in this manual have not been followed
- Non-original spare parts are used

- There is any damage to the unit caused by operator error

COMPLIANCE

Roband® products have been designed and manufactured to comply with any and all specifications set out by the Australian Communications & Media Authority (ACMA) in regards to Electromagnetic Compatibility.

Roband® products bear the following compliance symbols:

- CE (European Standards) 
- RCM (Regulatory Compliance Mark)

CLEANING & MAINTENANCE

CAUTION: Disconnect from power and allow to cool before cleaning.

Season unit prior to use, refer to page 6.

Do not clean with the use of a water jet or immerse in water.

Do not use caustic or abrasive cleaning products as they will damage the appliance.

Wipe all surfaces of the appliance with warm soapy water using a **damp** non-abrasive cloth.

Empty grease tray on a daily basis or more frequently if required; wipe clean using a damp cloth with warm soapy water.

Regular cleaning will prevent a build-up of oils and keep the appliance looking new.

Never use any metal or abrasive scrubbers or cleaners on the plates of the unit.

Cooking residue should be carefully removed by gently scrubbing the plates with a nylon scrubber or scraper. Be cautious not to scrub back the plates too far (to the point the plates are shiny again) as the plates will need to be seasoned again, refer to page 6.

If plates become too difficult to clean using the above method, you may use a **non-caustic** oven cleaner by applying a small amount to the plates

and letting it sit for **no longer than 30 seconds** before wiping off the cleaner. Ensure all cleaner residue is removed from the Grill Station.

Note: Only use non-caustic oven cleaner when absolutely necessary. If the oven cleaner eats into the aluminium cooking surface immediately cease using the product for cleaning the Grill Station.

NON STICK COATED (T) SERIES

Plates should be cleaned regularly during use and at the end of each day using a soft cloth dampened with only hot soapy water, regular cleaning will prevent the build-up of food residue which leads to carbonisation and can lead to poor cooking performance, overheating and damage to the non-stick coating.

Any stubborn cooking residue should be carefully removed by gently scrubbing with a Nylon scrubber or scraper. We recommend the use of Nylon scrubbers. Do not under any circumstances use any metal or abrasive scrubbers or cleaners on non-stick coated plates.

INSTALLATION

Remove all packaging materials, tape, and any protective plastic from the appliance. Remove any glue residue from the protective plastic or tape using citrus cleaner.

Place the product on a firm, level surface in the desired position. Install at least 100mm from combustible materials and 100mm from any other appliance. If the Grill Station is to be used as a toaster it must not be placed under or near to combustible material due to the risk of the bread burning.

Do not connect to power using an extension cord.

Do not place the Grill Station above other equipment that may give off heat.

Before connecting the appliance to the power supply, ensure that all switches are in the OFF position. Connect only to an RCD protected, grounded 3-pin outlet.

The units must be wired into an RCD (Residual Current Device) rated at no less than 30mA for circuit protection.

A minimum of 100mm clearance all around the Grill Station should be provided to ensure proper function of the unit.

AUSTRALIAN MODELS

GSA610, GSA810, GSA610E, GSA810E models should be plugged into a single phase, 10 or 15 Amp power point.

GSA815, GSA815E models should be plugged into a single phase, 15 Amp power point.

EXPORT MODELS (-G, -F & -M)

Export models can plug into a standard 13 Amp UK (Type G), 16 Amp European (Type E or F) or South African (Type M) power point.

OPERATION OF GRILL STATIONS

All Models

Selector Switch

Displays the 2 different cooking functions of the unit; Contact Grill Mode & Hotplate Mode. A

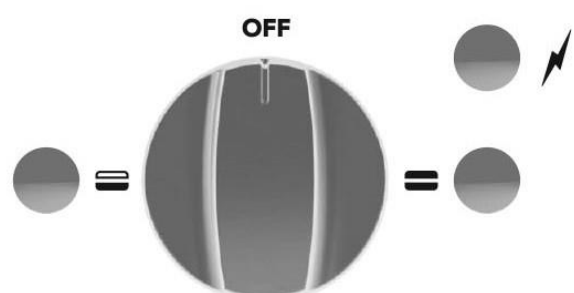

green light will illuminate if either of these are selected.

Contact Grill Mode  activates both the bottom and top plates, and will illuminate the amber light to the right of the switch.

Hotplate Mode  activates the bottom plate only and illuminates the amber light to the left of the switch.

Note: The amber lights will only illuminate as the plates are heating and will switch off once the temperature set by the thermostat is reached.

Thermostat

Controls the temperature of the plates as per the displayed rating. It is not necessary to turn the thermostat to "Off" when the unit is switched off.

Note: Non-stick coated units should **never** be set above 240°C.

Mechanically Timed Grill Stations

Models: GSA610, GSA810, GSA815

The timer is purely a mechanical device to provide an audible ring after the set time (each

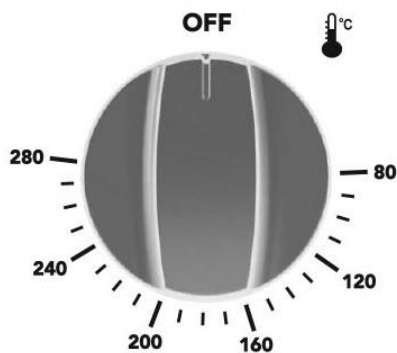

notation on the timer represents the amount of minutes it will countdown). It provides no control over the heating of the unit.

Electronically Timed Grill Stations

Models: GSA610E, GSA810E, GSA815E

The electronically timed models have **4 individual timers**, each with two pre-set time

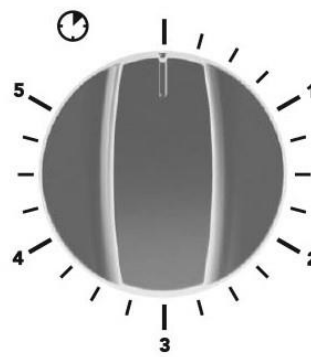

periods. The timers provide an audible beep after the pre-set time elapses, but do not provide any control over the heating of the unit.



1.1 Start Button

- Press once to start timer (countdown)
- Single press during countdown – **Pause timer.**
- Single press during pause – **Continue timer.**
- Press and hold at any time – **Reset timer to pre-programmed time.**

At the end of a time sequence, the timer display will flash and a buzzer will sound. Press the **Start** key to cancel the buzzer and reset the timer.



Each timer has a separate alarm sound as follows:

- Timer 1, one beep – pause – repeats 10 times.
- Timer 2, two beeps – pause – repeats 8 times.
- Timer 3, three beeps – pause – repeats 6 times.
- Timer 4 four beeps – pause – repeats 5 times.

1.2 Entering a temporary (one cycle) time.

Up or **Down** + **Start** pressed simultaneously. Time on the corresponding display starts flashing. Note minimum time setting, one

second, maximum time setting, 9 minutes 59 seconds.

One press of the **Up** or **Down**  key changes the pre-set time by one second, holding the **Up** or **Down**  key down continuously adjusts the time at a faster rate. Press **Start** button again to establish the new (single use) time setting.

Press the **Start** button again to begin the countdown.

1.3 Changing the default pre-set time settings.

Up + Down + Start pressed simultaneously. Time on corresponding display starts flashing. The time can be adjusted by using the **Up** or **Down**  keys, as noted above. Press the **Start** button again to save the new time as the default.

Press the **Start** button again to begin the countdown.

1.4 Changing to the second pre-set timer.

Press the **Start** button for 5 seconds until the time display changes to the second level pre-set time. Entering a temporary time or changing the pre-set time is that same as for the first level time.

ADDITIONAL INFORMATION

A short buzzer will sound to indicate a button was pressed each time any button is pressed.

If the unit is left on pause mode for 6 minutes, the unit will automatically exit pause mode and revert to the default time. The user must then manually press start again to begin countdown.

Pre-set factory times are detailed below.

Timer	Level	Pre-set time
1	1	1:23
	2	0:14
2	1	4:56

	2	0:08
3	1	6:54
	2	0:05
4	1	3:21
	2	3:37



SEASONING

Seasoning is only required for units without Non-Stick Coatings. Before cooking, follow the below:

- Wipe both plates clean and apply a liberal amount of vegetable oil.
- Turn unit onto Contact Grill Mode  & set thermostat to 180°C.
- Once temperature is reached – carefully wipe off any excess oil.

Caution: Take care when wiping off excess oil as the plates and the oil will be hot.

COOKING

- Lightly grease or oil the plates and set the **Thermostat** to the desired cooking temperature.
- Adjust the selector switch to Hot Plate  or Contact Grill  mode as required.
- Allow a warm up time of around 15 minutes to pre-heat the plates before using for the first time each day.
- Place the food on the bottom plate and close the top plate onto the food if using the Contact Grill  mode.
- A timer is provided with all GS Series Grill Stations. This timer should be used as a guide only.

Warning: The timer does not turn off the heating elements when the bell sounds. Keep the lid closed when not cooking to minimise heat loss

and avoid high temperatures in the handle. The thermostat can be turned down to 150°C to save power.

CAUTION

During Hotplate Mode  the heat from the bottom plate will flow upwards and warm the handle. Although it should not get too hot, care should be taken when touching the handle during and after hotplate operation.

Additionally, when operating **do not** leave the plates open for extended periods while in Contact Grill Mode  because the handle will become hot to touch.

TROUBLESHOOTING

If the Grill Station does not function check the following points before calling for service.

- ✓ The appliance is plugged in correctly and the power switched on.
- ✓ The power point is not faulty.
- ✓ The on/off switch is not in the OFF position.
- ✓ The thermostat is not set to OFF.
- ✓ The thermostat and on/off switch knob are not loose or broken, rendering the switches inoperable.
- ✓ Check 'Circuit Protection' regarding unwanted tripping of RCD's.

If the top plate is toasting faster than the bottom plate.

- ✓ Check that there is no carbon build-up on the bottom plate. Carbon on the plates will act as an insulator and reduce toasting performance. Refer to "Cleaning Care & Maintenance".

If the top plate is not toasting

- ✓ Check that the unit is not switched to "Hotplate mode". 

CIRCUIT PROTECTION

Kitchen appliances must be backed up by the necessary level of circuit protection to comply with AS/NZ3000. A GSA must be cabled into a circuit backed up by a Residual Current Device (RCD), which is a protective device that automatically disconnects the live conductors of a circuit when an earth leakage current reaches a predetermined value.

Australian and International Standards detail when and where RCD's are to be used in electrical installations, but common practice in many countries is to use 30mA RCD's in general commercial applications.

For commercial installations and for socket-outlets providing power to commercial heating equipment, 30mA RCD's are typically unsuitable unless they are protecting only one device. Higher rated RCD's should be considered if protecting multiple socket-outlets, giving appropriate consideration to the type of equipment being protected.

AS/NZS3000 2.5.2 gives the following warnings that should have been taken into consideration when an RCD circuit was installed.

To avoid unwanted tripping due to leakage currents and transient disturbances, care should be taken to ensure that the sum of the leakage currents of electrical equipment on the load side of an RCD is less than 1/3 of its rated residual current.

Tubular elements reaching temperatures greater than 110°C are subject to moisture absorption and therefore earth leakage current generation. Should the installation and use of this unit trip an RCD the unit will need to be run on a circuit without an RCD for approximately 30-60 minutes, after which time the elements should have dried out and the machine should function normally.

PARTS LIST

Common

DC0116	Left Handle Arm
DC0117	Right Handle Arm
EC0031	Terminal Block 10mm ² Porcelain/Steatite, L & N marked,
EC0642	10 Amp – Black – Plug & Cord (10A models only)
EC0643	15 Amp – Black – Plug & Cord (15A models only)
ES0264	10mm ² Amber Pilot Light/O-ring
ES0265	10mm ² Green Pilot Light/O-ring
ES0258	3 Position Rotary Switch & Knob
MC0844	Tension Spring (GSA6 only)
MS0583	Appliance Knob
MC0872	Tension Spring (GSA8 only)
MC1233	GSA Roller Bearing & Bracket
PC0060	Cord Clamp (10 Amp Only)
PC0061	Cord Clamp (15 Amp Only)
PC0146	Washers (ø1/4", ø1/2", ø1/16")
PC0418	Sintered PTFE Bush
PS0129	Foot & Foot Cap (4 off) Includes Bolts, Nuts & Washers
TS0020	Thermostat (50°-285°C) + Knob
VS0241	Grill Station Minimelt Spares Kit
VS0267	GSA6 Handle & Arms Assembly
VS0268	GSA8 Handle & Arms Assembly

GSA610S / GSA610R

HC0168	Smooth Top Element & Plate 900W (GSA610S Only)
HC0184	Ribbed Top Element & Plate 900W (GSA610R Only)
HC0169	Bottom Element & Plate 1300W
MS0519	5 Min Mechanical Timer
SS2415	Grease Box

GSA810S / GSA810R

HC0189	Bottom Element & Plate 1410W
HC0190	Smooth Top Element & Plate 890W (GSA810S Only)
HC0191	Ribbed Top Element & Plate 890W (GSA810R Only)
MS0519	5 Min Mechanical Timer
SS2503	Grease Box

GSA815S / GSA815R

HC0197	Bottom Element & Plate 1820W
HC0198	Smooth Top Element & Plate 1170W (GSA815S Only)
HC0199	Ribbed Top Element & Plate 1170W (GSA815R Only)
MS0519	5 Min Mechanical Timer
SS2503	Grease Box

GSA610E / GSA810E / GSA815E

EC0549	Digital Timer
DC0170	Timer Bezel
NC0142	Timer Decal
SS3173	Grease Box (GSA610E Only)
SS3174	Grease Box (GSA810E & GSA815E)
International Models – G, F & M	
EC0635	15 Amp – Plug & Cord Type F
EC0644	13 Amp – Plug & Cord Type G
EC0646	15 Amp – Plug & Cord Type M

Note: for Teflon coated plates (non-stick), add suffix "T" to element and plate part number e.g. HCXXXXT.

CIRCUIT DIAGRAMS

Mechanically Timed Units

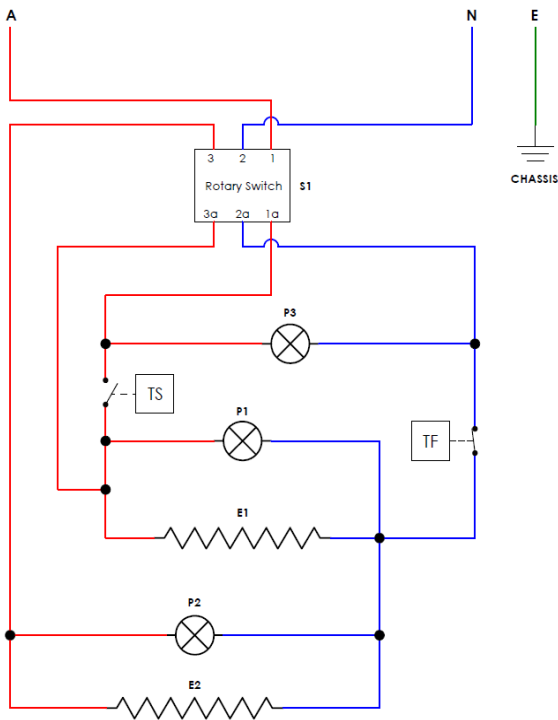

ITEM	DESCRIPTION
E1	BOTTOM ELEMENT HOTPLATE
E2	TOP ELEMENT HOTPLATE
P1	BOTTOM PILOT LIGHT - AMBER
P2	TOP PILOT LIGHT - AMBER
P3	ON/OFF PILOT LIGHT - GREEN
S1	ROTARY SWITCH
TF	THERMAL FUSE
TS	THERMOSTAT

Electronically Timed Units

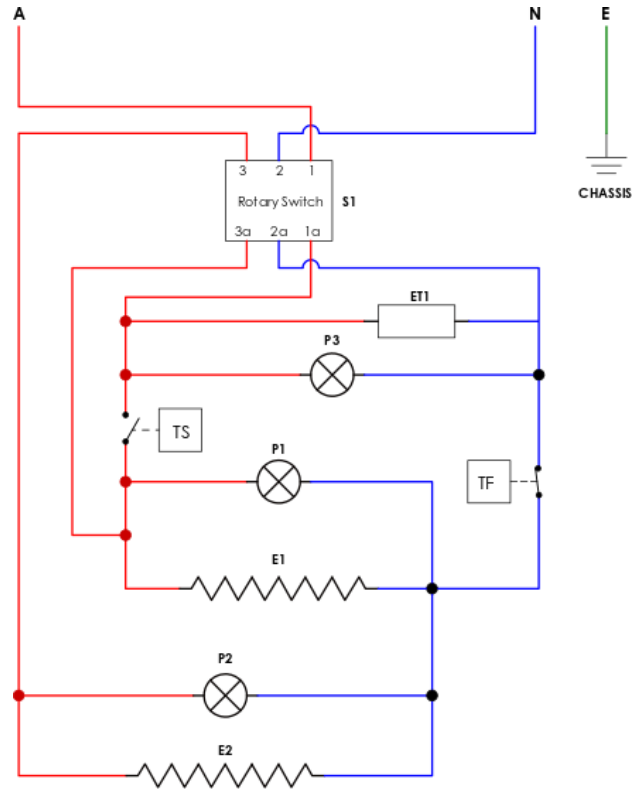

ITEM	DESCRIPTION
E1	BOTTOM ELEMENT HOTPLATE
E2	TOP ELEMENT HOTPLATE
P1	BOTTOM PILOT LIGHT - AMBER
P2	TOP PILOT LIGHT - AMBER
P3	ON/OFF PILOT LIGHT - GREEN
S1	ROTARY SWITCH
TF	THERMAL FUSE
TS	THERMOSTAT
ET1	ELECTRONIC TIMER

Special Note: These circuit diagrams have been provided for reference and to assist qualified service and repair agents only. Under no circumstances should persons not suitably qualified attempt repairs to any electrical equipment.

HEAT SHIELD INSTALLATION

Installation

1. Grill Station **MUST** be cool to touch before installing.
2. Place heat shield over top cover, aligning centre cutout over the pivot bush.

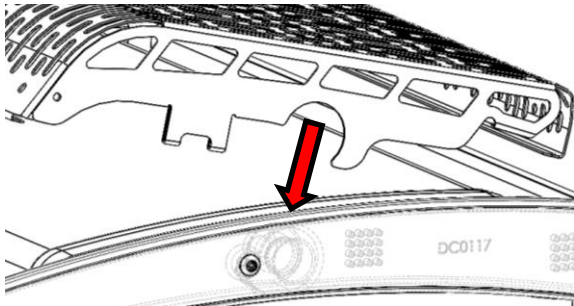
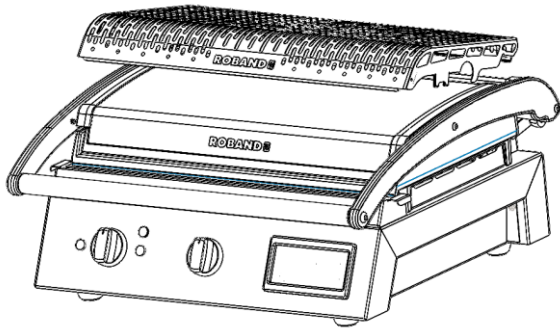

3. Lever heat shield lock tabs over the top cover retainers and slide the heat shield onto the top cover. You will hear a 'click' as the lock tabs engage and the heat shield installation is complete.

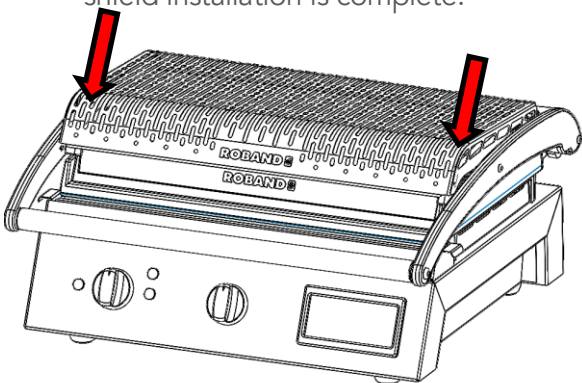

Removal

1. Grill Station **MUST** be cool to touch before removing.
2. Open the Grill Station up and locate the Heat Shield locking clips towards the front of the heat shield.

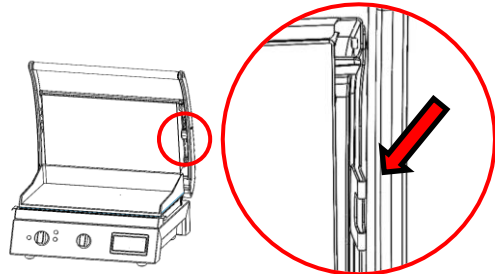

3. Using your fingers, push either the Left or Right clip outward to clear the top cover and lever up at the same time. Repeat the process on the alternate side, then slide away from machine.

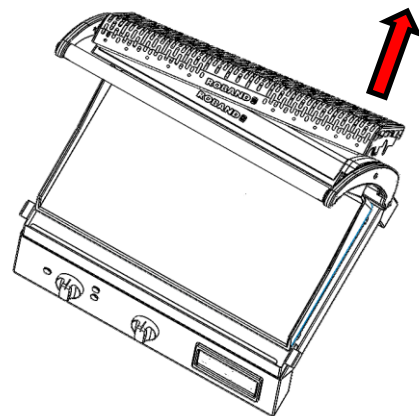
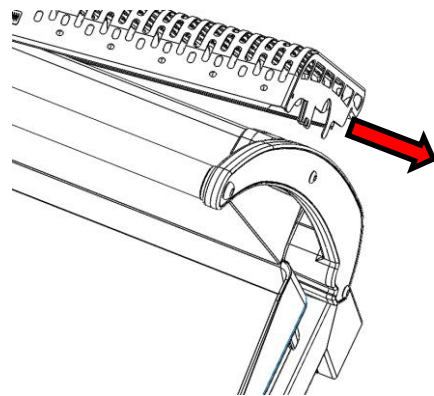

WARRANTY

The warranty conditions set out below are in addition to any warranties implied or governed by law.

Roband Australia warrants that this appliance shall be delivered free from defects in material and workmanship. The warranty for this product is offered to the original purchaser, to be free of fault in both workmanship and materials for a period of 12 months from date of purchase. Roband's obligations pursuant to this warranty are limited to the repair or replacement of the defective goods or materials, at its discretion and subject to the terms contained within this Warranty statement.

The following conditions apply:

The product must be installed, maintained and used under normal operating conditions within the scope of the operating instructions.

All warranty claims must be submitted to Roband or an authorised Roband dealer, and Roband authorisation must be granted prior to repairs being carried out. Proof of purchase is required for any repair authorisation.

Warranty is back to base, meaning delivery to and collection of your product to Roband or an authorized service agent is the responsibility of the purchaser.

Where a product cannot be returned back to base, on-site warranty can be arranged by prior agreement.

The following exclusions apply:

Claims or faults arising from misuse, neglect, transport damage or other mechanical damage, including but not limited to; door's, hinges & interlock switches etc., other than those arising from manufacture or material defects. Where relevant, glass, Teflon® and lamps are not included in this warranty and RCD tripping due to moisture absorption by Tubular Heating Elements is not a warranty fault.

Roband or any subsidiary company or Agent shall not be liable for loss of profit or damage to other equipment and property except where it is in breach of the guarantees provided in accordance with applicable legislation.

Roband reserves the right to reject a warranty claim if it is not satisfied with the circumstances under which the fault occurred or where a product has been altered from its original specification.

For on-site repairs outside of capital city metropolitan areas, travel costs, service callout fee and related labour costs etc. are the responsibility of the claimant.

Any costs incurred for false claims or faults due to incorrect usage etc. are the responsibility of the claimant.

Any attempt to repair the product by non-Roband approved service personnel or the use of non-genuine parts will void the warranty agreement

Our goods come with guarantees that cannot be excluded under the Australian Consumer Law. You are entitled to a replacement or refund for a major failure and compensation for any other reasonably foreseeable loss or damage. You are also entitled to have the goods repaired or replaced if the goods fail to be of acceptable quality and the failure does not amount to a major failure.

For the name of your nearest Australian authorised service agent, please contact:

Roband Australia Pty Ltd
1 Inman Road,
Cromer, NSW, 2099, Australia
Warranty: 1800 268 848
Tel: +61 2 9971 1788
Email: sales@roband.com.au
Web: www.roband.com.au

For your nearest International distributor,
please visit:
<https://www.roband.com.au/global/>



© Copyright 2021 – Roband® Australia Pty Ltd

All rights reserved. No part of this work may be reproduced or copied in any form or by any means, electronic or mechanical, including photocopying or posting to a website, without the written permission of the publisher. The material contained within this document is intended entirely for instructional Purposes. Roband® Australia is a wholly Australian owned company and has been manufacturing quality commercial catering equipment for the food service industry for more than 60 years.

27/10/2023